

**FORMULARIO PER IL CALCOLO
DELLE CARATTERISTICHE STATICHE
DELLA SEZIONE**

R = raggio esterno
 r = raggio interno
 \emptyset = $2 r$
 s = spessore
 F = area teorica sezione

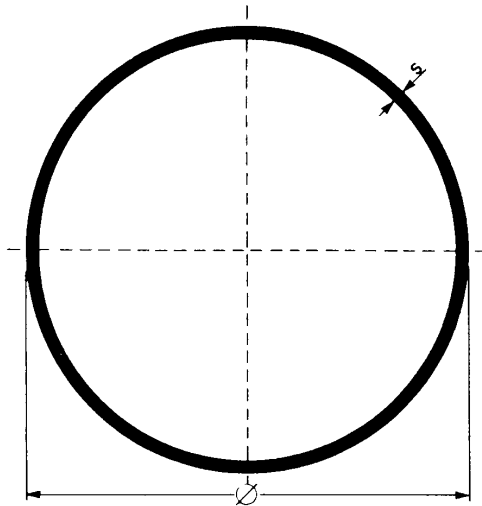

$J_x = J_y$ = momento d'inerzia riferito agli assi x e y.

$J_o = 2J_x = 2J_y$ = momento polare d'inerzia

$W_x = \bar{W}_y$ = modulo di resistenza riferito agli assi x e y

$i_x = i_y$ = raggio inerzia riferito agli assi x e y.

$F = \pi (R^2 - r^2)$

$J_x = J_y = \pi/4 (R^4 - r^4)$

$W_x = W_y = \pi/4 (R^4 - r^4)/R$

tubi saldati
da nastro laminato a caldo

TUBO TONDO

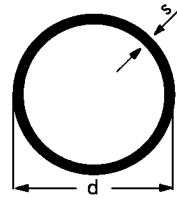

DIMENSIONE mm " d "	spessore mm						
	1,5	2	2,5	3	4	5	6
	peso in Kg./mt.						
14	0,462	0,592					
15	0,499	0,641					
16	0,536	0,690					
18	0,610	0,788					
20	0,684	0,887	1,079				
22	0,757	0,985	1,202				
24	0,832	1,085					
25	0,868	1,130	1,387				
26	0,906	1,184	1,449				
28	0,979	1,281	1,572				
30	1,053	1,380	1,695	2,00			
32	1,127	1,478	1,819				
35	1,238	1,626	2,003	2,37			
38	1,349	1,776	2,189				
40	1,423	1,873	2,311	2,74			
42	1,497	1,971	2,435				
45	1,608	2,119	2,620				
48	1,719	2,267	2,805				
50	1,793	2,366	2,928	3,48			
55	1,980	2,610	3,230	3,85			
60	2,162	2,859	3,544	4,21	5,52		
70	2,533	3,350	4,160	4,96	6,51		
76	2,755	3,650	4,530	5,40	7,10		
80	2,903	3,850	4,780	5,70	7,50		
89	3,237	4,290	5,330	6,36	8,38		
100		4,830	6,010				
102		4,930	6,130	7,32	9,67		
114		5,520	6,870	8,21	10,85		
121				8,67	11,54	14,30	17,02
127				9,17	12,13	15,04	17,90
133				9,62	12,72	15,78	18,79
139				10,06	13,32	16,52	19,68
152				11,02	14,60	18,13	21,60
159				11,54	15,29	18,99	22,64
168				12,21	16,18	20,10	23,97
193,7				13,98	18,55	23,06	27,52
219				15,98	21,21	26,39	31,06

**FORMULARIO PER IL CALCOLO
DELLE CARATTERISTICHE STATICHE
DELLA SEZIONE**

- A = lato
s = spessore
F = area teorica della sezione
 $J_x = J_y$ = momento d'inerzia riferito agli assi x e y.
 $W_x = W_y$ = modulo di resistenza riferito agli assi x e y
 $i_x = i_y$ = raggio inerzia riferito agli assi x e y

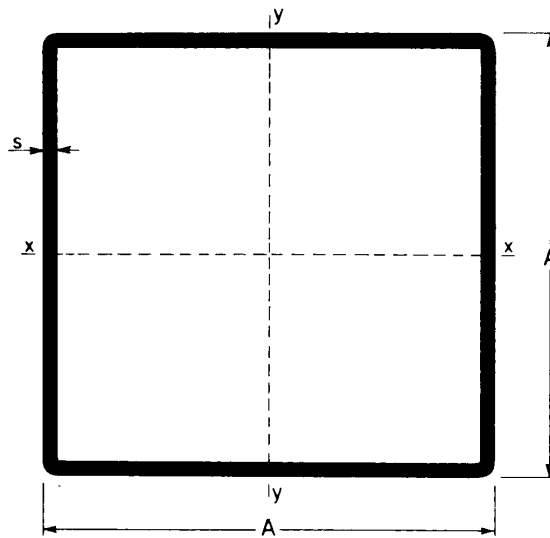

$$F = A^2 - (A - 2s)^2 = 4As - 4s^2$$

$$J_x = J_y = \frac{A^4 - (A - 2s)^4}{12}$$

$$W_x = W_y = \frac{2J_x}{A}$$

$$i_x = i_y = \sqrt{\frac{J_x}{F}}$$

tubi saldati
da nastro laminato a caldo

TUBO QUADRO

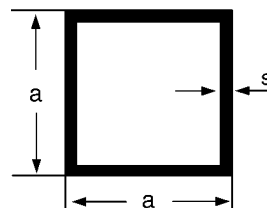

DIMENSIONE mm a x a	spessore mm							
	1,5	2	3	4	5	6	7	8
	peso in Kg./mt.							
12 x 12	0,499							
14 x 14	0,590	0,79						
15 x 15	0,636	0,84						
16 x 16	0,683	0,89						
18 x 18	0,758	0,99						
20 x 20	0,872	1,13	1,60					
22 x 22	0,966	1,28						
24 x 24	1,050	1,38						
25 x 25	1,107	1,47	2,07					
28 x 28	1,240	1,63	2,37					
30 x 30	1,343	1,76	2,57	3,35				
35 x 35	1,578	2,11	3,09	4,04				
40 x 40	1,814	2,45	3,60	4,09	4,83			
45 x 45	2,050	2,70	3,97	5,23				
50 x 50	2,270	3,01	4,45	5,35	6,40	7,99		
55 x 55	2,530	3,35	4,96	6,51	8,01			
60 x 60	2,756	3,62	5,36	6,61	7,97	9,20	11,65	13,06
70 x 70	3,227	4,26	6,32	7,86	9,54	11,10	12,53	15,57
80 x 80	3,710	4,90	7,30	9,12	11,10	12,99	14,74	16,36
90 x 90			8,20	10,38	12,67	14,86	16,94	18,87
100 x 100		6,15	9,15	11,64	14,26	16,76	19,14	21,41
120 x 120			11,05	14,15	17,40	20,63	23,54	26,44
150 x 150			13,85	17,92	22,11	26,19	30,14	33,98
175 x 175			16,02	21,15	26,02	30,87	35,61	40,23

**FORMULARIO PER IL CALCOLO
DELLE CARATTERISTICHE STATICHE
DELLA SEZIONE**

- A** = lato maggiore
B = lato minore
s = spessore
F = area teorica della sezione
J_x = momento d'inerzia riferito all'asse x
J_y = momento d'inerzia riferito all'asse y.
W_x = modulo di resistenza riferito all'asse x
W_y = modulo di resistenza riferito all'asse y
i_x = raggio d'inerzia riferito all'asse x
i_y = raggio d'inerzia riferito all'asse y
F = $BA - (B - 2s)(A - 2s) = 2s(B + A - 2s)$

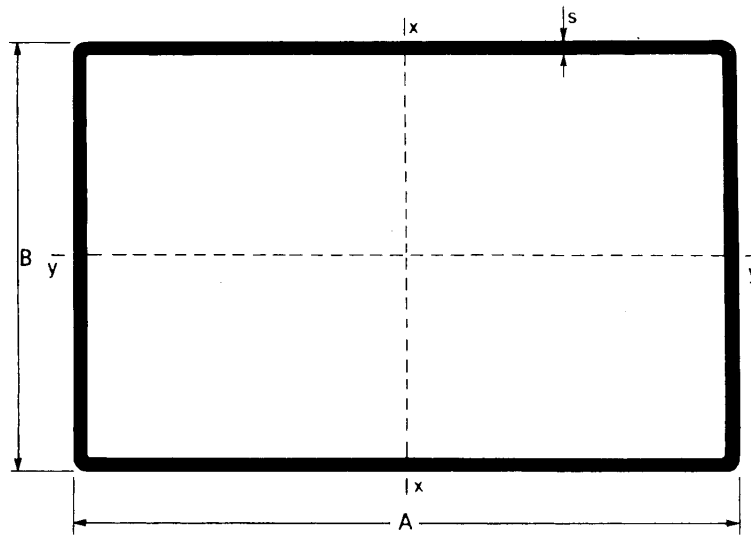

$$J_x = \frac{B \times A^3 - (A - 2s)^3 (B - 2s)}{12}$$

$$J_y = \frac{A \times B^3 - (B - 2s)^3 (A - 2s)}{12}$$

$$W_x = \frac{2 J_x}{A}$$

$$W_y = \frac{2 J_y}{B}$$

$$i_x = \sqrt{\frac{J_x}{F}}$$

$$i_y = \sqrt{\frac{J_y}{F}}$$

tubi saldati
da nastro laminato a caldo

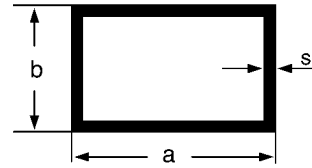

TUBO RETTANGOLO

DIMENSIONE mm a x b	spessore mm							
	1,5	2	3	4	5	6	7	8
	peso in Kg./mt.							
20 x 10	0,647	0,839						
20 x 15	0,757	0,986						
25 x 10	0,757	0,986						
25 x 15	0,868	1,140						
30 x 10	0,868	1,140						
30 x 15	0,979	1,280						
30 x 20	1,127	1,470	2,140					
30 x 25	1,238	1,620	2,310					
35 x 10	0,979	1,280						
35 x 15	1,127	1,470						
35 x 20	1,238	1,620	2,310					
35 x 25	1,349	1,760						
40 x 10	1,127	1,470						
40 x 15	1,238	1,620						
40 x 20	1,349	1,760	2,570					
40 x 25	1,497	1,960	2,860					
40 x 30	1,608	2,110	3,090					
45 x 15	1,349	1,760						
45 x 20	1,497	1,960	2,860					
50 x 10	1,349	1,760						
50 x 15	1,497	1,960						
50 x 20	1,608	2,110	3,090					
50 x 25	1,719	2,250	3,310					
50 x 30	1,793	2,450	3,600	4,520				
50 x 40	2,049	2,700	3,970	4,830				
60 x 15	1,719	2,250						
60 x 20	1,793	2,450	3,600					
60 x 25	1,931	2,600	3,820					
60 x 30	2,049	2,700	3,970	4,830				
60 x 40	2,284	3,010	4,450	5,350	7,150			
60 x 50		3,330	4,920	6,080				

tubi saldati
da nastro laminato a caldo

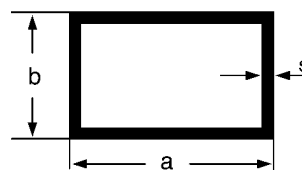

TUBO RETTANGOLO

DIMENSIONE mm a x b	spessore mm							
	1,5	2	3	4	5	6	7	8
	peso in Kg./mt.							
70 x 20	2,049	2,70	3,97					
70 x 25	2,160	2,86	4,21					
70 x 30	2,284	3,01	4,45					
70 x 40	2,520	3,33	4,92	6,08	7,18			
70 x 50	2,750	3,65	5,40	7,10	7,96			
80 x 15	2,160	2,86						
80 x 20	2,284	3,01	4,45					
80 x 30	2,520	3,33	4,92					
80 x 40	2,750	3,65	5,40	7,10	7,96	9,20		
80 x 50	3,010	3,97	5,88	7,24	8,75			
80 x 60	3,230	4,26	6,32	7,86	10,36	11,09		
90 x 30	2,750	3,65	5,40	7,10				
90 x 40	3,010	3,97	5,88	7,24	8,75			
90 x 50	3,230	4,26	6,32	7,86	10,36	11,09		
90 x 60		4,59	6,81	8,98	11,10			
100 x 20	2,750	3,65	5,40	7,10				
100 x 30		3,97	5,88	7,24				
100 x 40		4,26	6,32	7,86	10,36			
100 x 50		4,59	6,81	8,98	11,10	13,17		
100 x 60		4,90	7,30	9,11	11,96	14,12		
100 x 80		5,50	8,20	10,80	13,35	15,82	16,94	20,40
120 x 30		4,59	6,81	8,98	11,10	13,17		
120 x 40		4,90	7,30	9,11	11,96	14,12		
120 x 50		5,26	7,77	10,26	12,56	14,88		
120 x 60		5,50	8,20	10,80	13,35	15,82	16,94	20,40
120 x 80		6,15	9,15	11,63	14,24	16,76	19,12	21,39
130 x 50		5,50	8,20	10,80	13,35	15,82		
130 x 60		5,87	8,73	11,46	14,31	17,02		
140 x 40		5,50	8,20	10,80	13,35			

tubi saldati
da nastro laminato a caldo

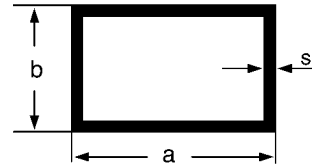

TUBO RETTANGOLO

DIMENSIONE mm a x b	spessore mm						
	2	3	4	5	6	7	8
	peso in Kg./mt.						
140 x 60	6,15	9,15	11,63	14,24	16,76		
140 x 70		9,37	12,27	15,03	17,70	20,35	
140 x 80		9,90	12,99	15,81	18,62	21,32	25,62
150 x 40	5,87	8,73	11,46	14,31	17,02		
150 x 50	6,15	9,15	11,63	14,24	16,76		
150 x 60		9,37	12,27	15,03	17,70		
150 x 100		11,26	14,77	18,17	21,47	26,25	29,81
160 x 60		9,90	12,99	15,81	18,62		
160 x 80		11,05	14,14	17,38	20,53	25,05	28,43
180 x 60		11,05	14,14	17,38	20,53	25,05	28,43
180 x 80		12,23	16,21	20,14	24,02	27,81	31,59
200 x 100		13,85	17,91	22,09	26,19	32,25	36,66
200 x 150		15,98	21,23	26,41	31,55		
220 x 80		13,85	17,91	22,09	26,19	32,25	36,66
250 x 100		15,98	21,23	26,41	31,55	36,63	41,67

tubi saldati
da nastro laminato a caldo

TUBO OVALE - SEMIOVALE - ELLITTICO - TRIANGOLO

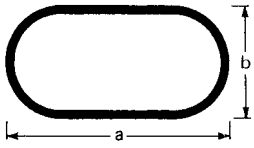
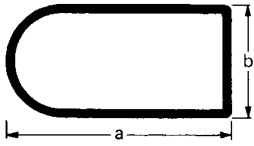
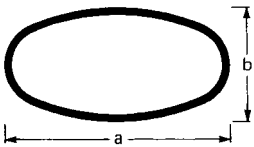
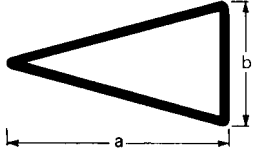
	DIMENSIONE mm "a" x "b"	spessore mm	
		1,5	2
		peso in Kg./mt.	
OVALE 			
	30 x 15	0,853	
	36 x 18	1,050	
	40 x 20	1,160	
	50 x 25	1,458	
	60 x 30	1,790	2,366
	80 x 25	2,070	
SEMIOVALE 			
	40 x 20	1,248	
	40 x 25	1,341	
	50 x 25	1,610	
ELLITTICO 			
	30 x 15	0,758	
	40 x 20	1,050	
	100 x 50		3,855
TRIANGOLO 			
	30 x 15	0,860	1,130

tubi saldati
da nastro laminato a caldo

TUBOLARI PER SERRAMENTI spess. mm 1,5

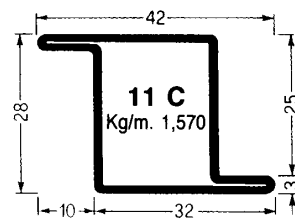
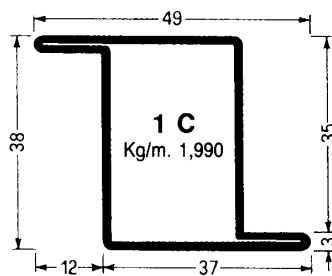
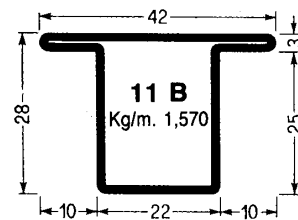
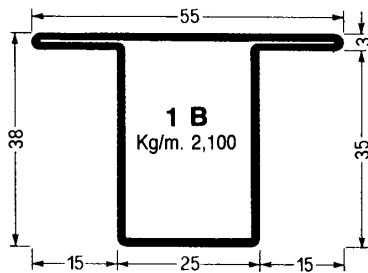
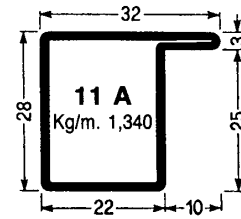
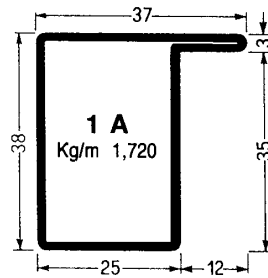

tubi saldati
da nastro laminato a caldo

TUBOLARI PER SERRAMENTI spess. mm 1,5

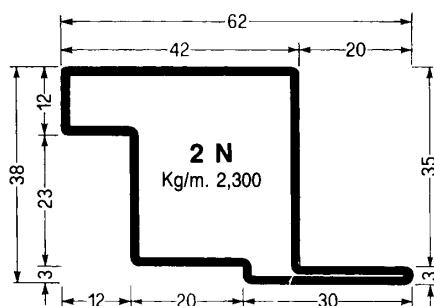
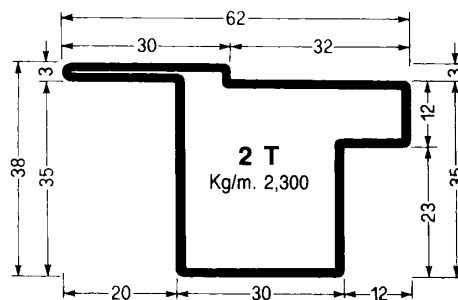
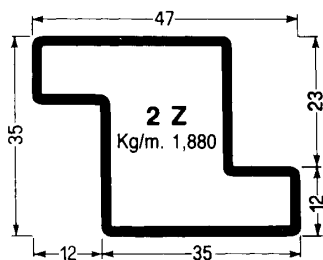
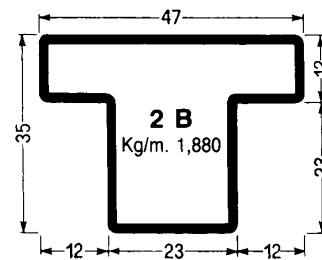
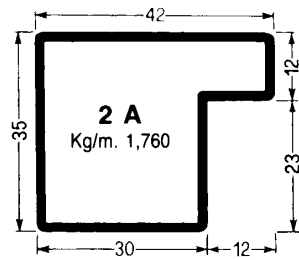

FERMAVETRO A SCATTO

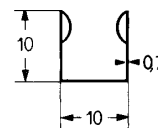

peso m Kg 0,203

tubi saldati
da nastro laminato a caldo

TUBOLARI PER PORTONI **spess. mm 1,5**

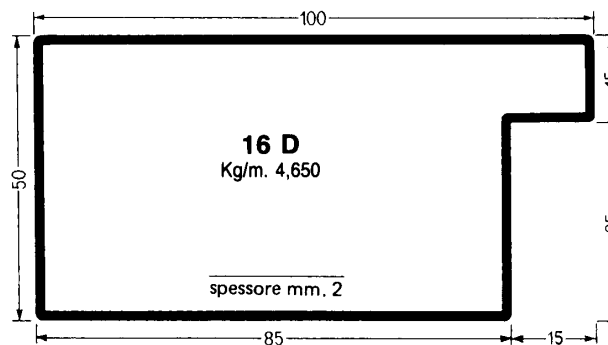
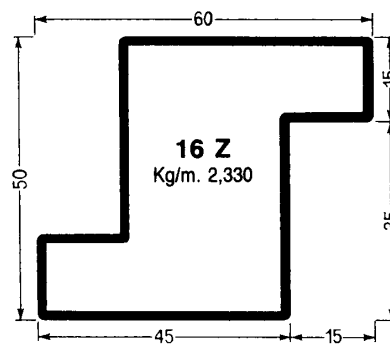
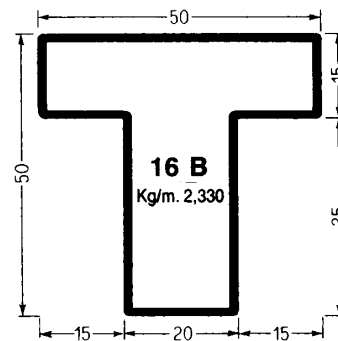
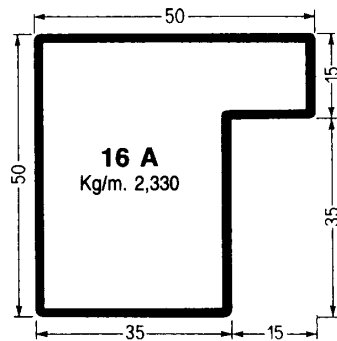

TUBOLARI PER SERRAMENTI spess. mm. 1,5

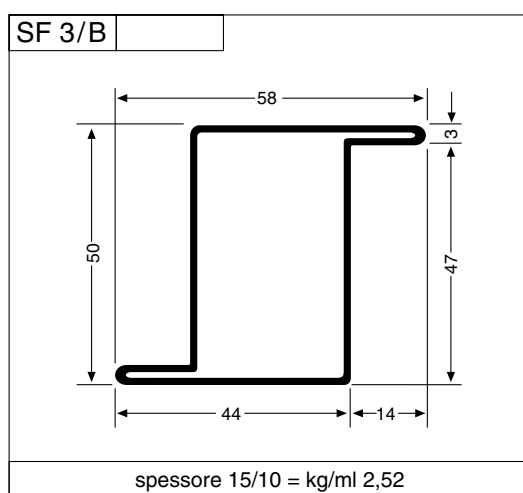
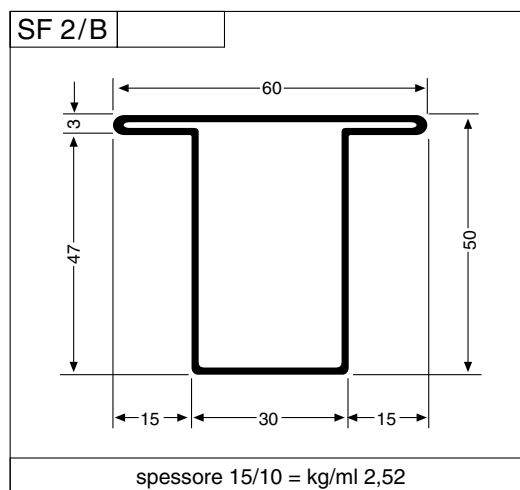
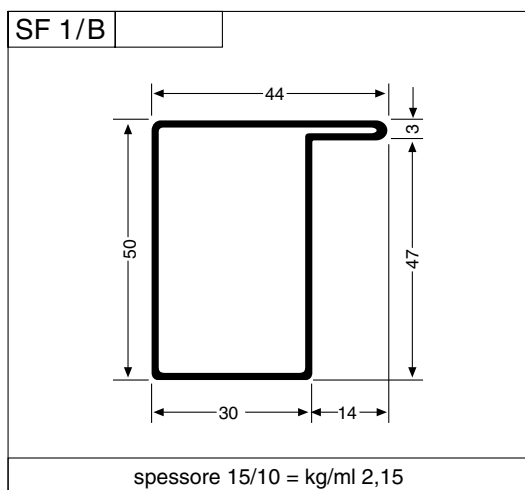

tubi saldati
da nastro laminato a caldo

MONOROTAIE

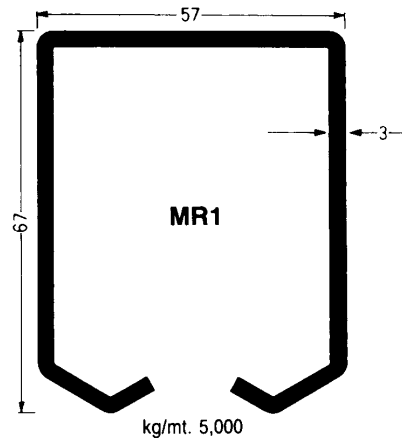

TIPO PER CARRELLI GRANDI

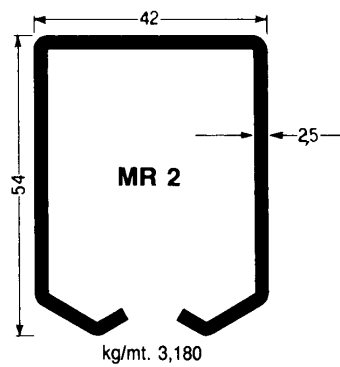

TIPO PER CARRELLI PICCOLI

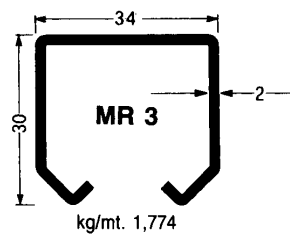

TIPO PER CARRELLI MIGNON

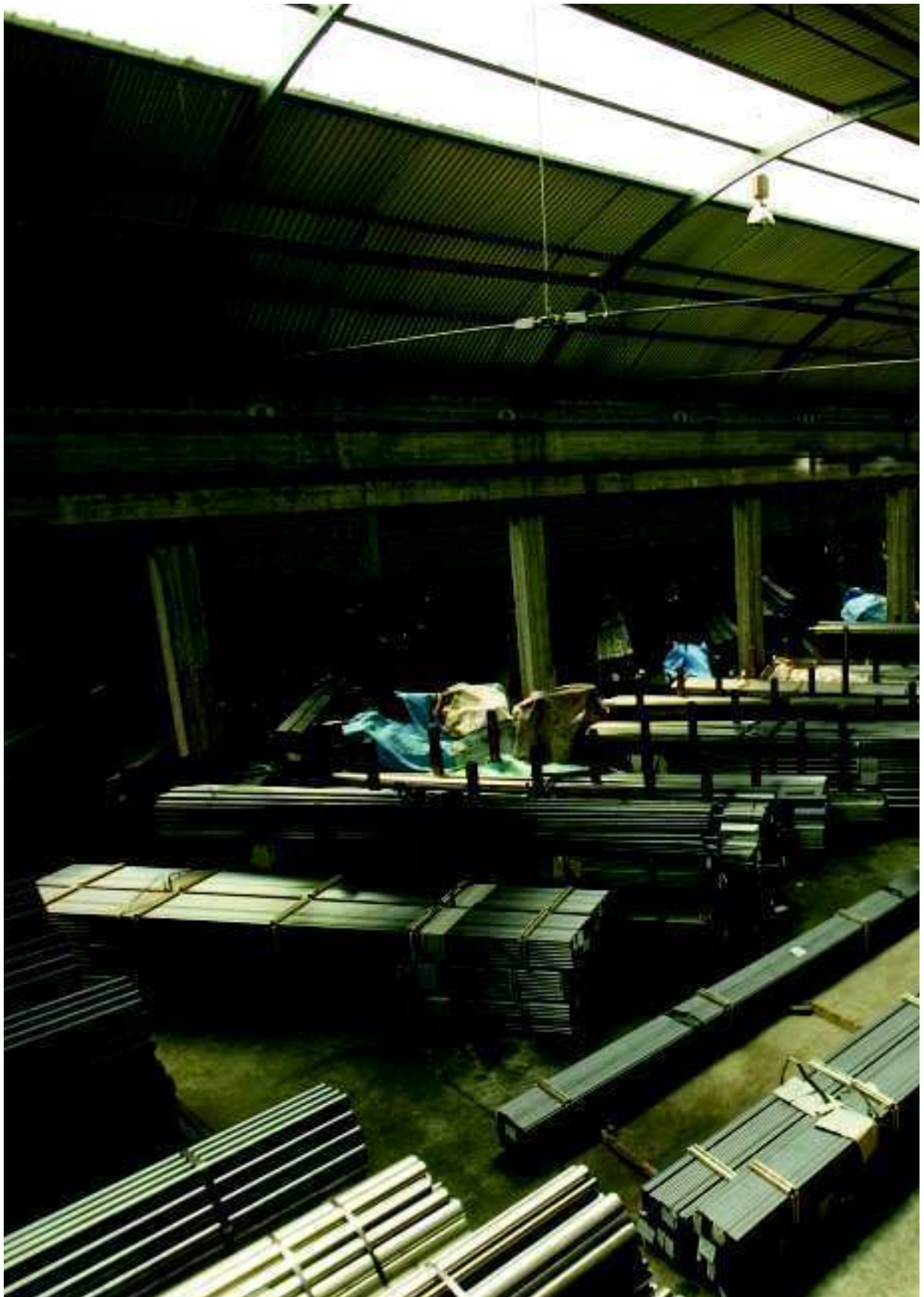

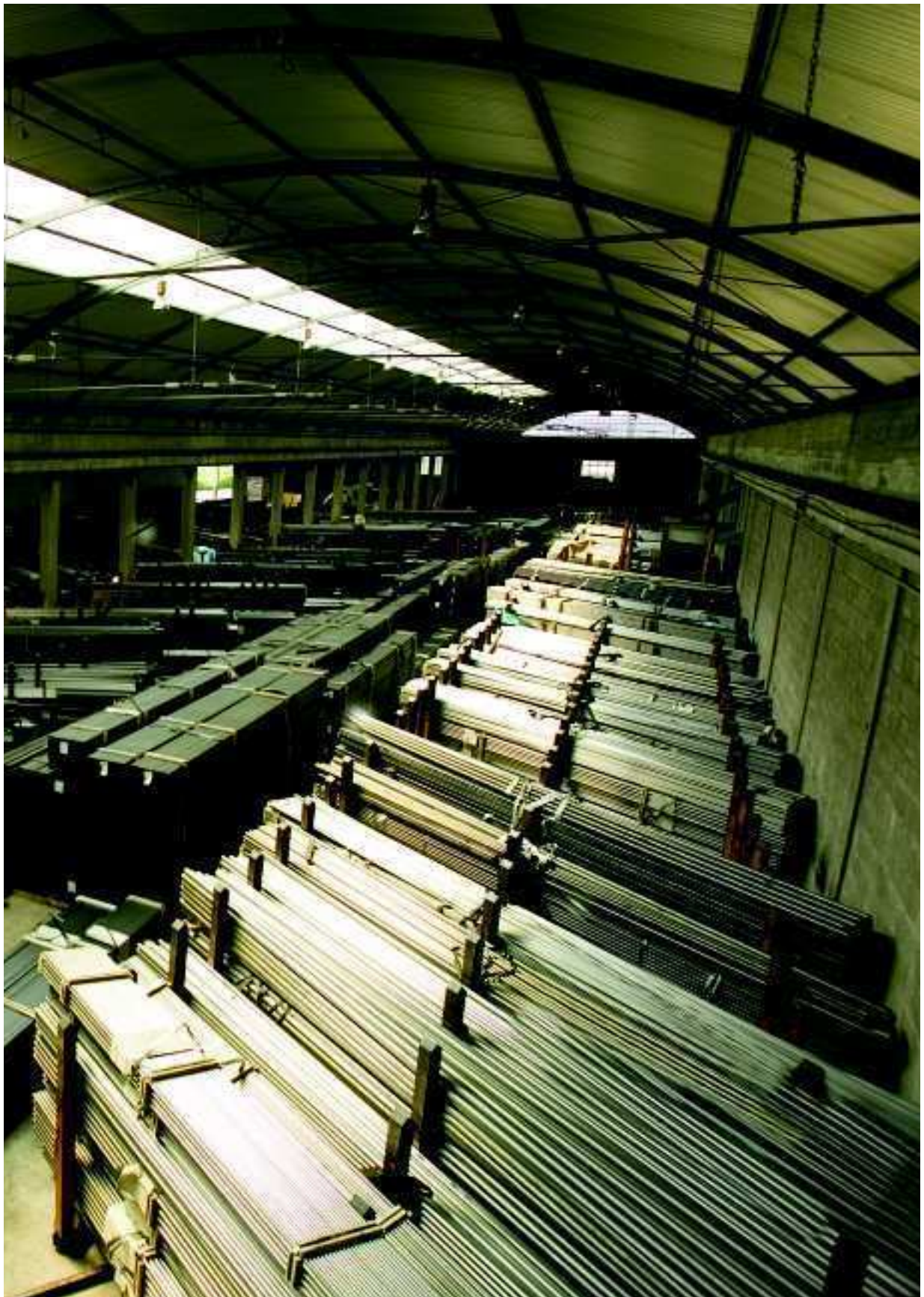

tubi saldati
da nastro laminato a caldo

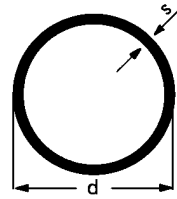

TUBO CARPENTERIA

Ø ESTERNO pollici	Ø ESTERNO mm	spessore mm								
		2	2,5	2,65	2,8	3	4	5	6	8
		peso in kg./mt.								
1/2	21,2	0,95								
3/4	26,7		1,49							
1	33,7			2,02						
1.1/4	42,4				2,73					
1.1/2	48,3				3,14					
2	60,3				3,97					
2.1/2	76,1				5,06					
3	88,9				5,94					
3.1/2	101,6					7,27	9,63			
4	114,3					8,16	10,06			
4.1/4	121					8,67				
4.1/2	127					9,17	12,13			
4.3/4	133					9,62	12,73			
5	139,7						13,39	16,61		
5.1/2	152,4						11,02	14,64	18,18	
5.3/4	159							15,29	18,99	
6	168,3									
7	193,7									
8	219,1									
9	244,5									
10	273									
12	323,9									
14	355,6									
16	406,4									
20	508									

tubi saldati
da nastro laminato a caldo

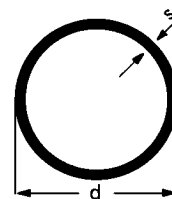

TUBO CARPENTERIA ZINCATO

Ø ESTERNO pollici	Ø ESTERNO mm	SPESSORE mm	PESO kg./mt.
3/4	26,7	2,6	1,59
1	33,7	2,7	2,16
1.1/4	42,4	2,9	2,88
1.1/2	48,3	2,9	3,31
2	60,3	2,9	4,22
2.1/2	76,1	2,9	5,37
3	88,9	2,9	6,30



Diametro esterno mm	spessore mm																				
	2,65	2,9	3,25	3,65	4,05	4,5	5	5,4	5,9	6,3	7,1	8	8,8	10	11	12,5	14,2	16	17,5	20	22,2
	peso kg./mt.																				
21,3	1,22	1,32	1,43	1,57	1,71	1,86	1,99														
26,9	1,58	1,72	1,87	2,07	2,26	2,49	2,70	2,90													
33,7		2,20	2,41	2,67	2,93	3,24	3,54	3,80	4,07	4,26	4,66										
38		2,51	2,75	3,05	3,35	3,72	4,07	4,40	4,70	4,93	5,41										
42,4		2,82	3,09	3,44	3,79	4,21	4,61	4,92	5,30	5,61	6,18	6,79									
44,5			3,26	3,63	4,00	4,44	4,87	5,20	5,62	5,94	6,55	7,20									
48,3			3,56	3,97	4,37	4,86	5,34	5,71	6,17	6,53	7,21	7,95	8,56	9,45	10,10	11,00					
51			3,77	4,21	4,64	5,16	5,67	6,07	6,56	6,94	7,69	8,48	9,10	10,10	10,90	11,90					
54			4,01	4,47	4,93	5,49	6,04	6,47	7,00	7,41	8,21	9,08	9,77	10,90	11,70	12,90					
57			4,25	4,74	5,23	5,83	6,41	6,87	7,44	7,88	8,74	9,67	10,40	11,60	12,50	13,80	15,00				
60,3			4,51	5,03	5,55	6,19	6,82	7,31	7,92	8,39	9,32	10,30	11,20	12,40	13,40	14,80	16,20				
63,5				5,32	5,87	6,55	7,21	7,74	8,38	8,89	9,88	10,90	11,90	13,20	14,30	15,80	17,30	18,70			
70				5,90	6,51	7,27	8,01	8,60	9,33	9,90	11,00	12,20	13,30	14,80	16,00	17,80	19,60	21,20	22,60		
76,1				6,44	7,11	7,95	8,77	9,41	10,21	10,80	12,10	13,40	14,60	16,30	17,70	19,70	21,70	23,70	25,30		
82,5				7,00	7,74	8,66	9,56	10,27	11,15	11,80	13,20	14,70	16,00	17,90	19,50	21,70	24,00	26,20	28,00	30,80	
88,9				7,57	8,38	9,37	10,30	11,12	12,08	12,80	14,30	16,00	17,40	19,50	21,20	23,70	26,20	28,70	30,80	34,00	36,50

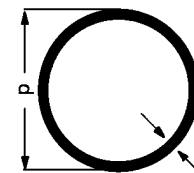

Diametro esterno mm	spessore mm																				
	6,3	7,1	8	8,8	10	11	12,5	14,2	16	17,5	20	22,2	25	28	30	36	40	45	50	55	60
	peso kg./mt.																				
95	13,8	15,4	17,2	18,9	21,0	23,1	25,4	28,3	31,2	33,4	37,0	39,9	43,0								
101,6	14,9	16,6	18,4	20,1	22,6	24,7	27,6	30,7	33,7	36,2	40,2	43,5	47,5								
108	15,8	17,7	19,6	21,4	24,2	26,4	29,6	32,9	36,2	39,0	43,4	47,0	51,4	55,2	57,7						
114,3	16,8	18,8	20,9	22,8	25,7	28,1	31,6	35,1	38,6	41,6	46,5	50,4	55,3	59,5	62,3						
121	17,8	19,9	22,3	24,7	27,4	30,2	33,4	37,4	41,4	44,7	49,8	54,1	59,2	64,2	67,3						
127	18,8	21,0	23,4	25,5	28,9	31,6	35,5	39,6	43,6	47,2	52,8	57,4	63,2	68,3	71,7	80,8					
133	19,8	22,1	24,6	26,9	30,3	33,3	37,4	41,8	46,1	49,9	55,7	60,8	67,1	72,5	76,3	86,1	91,7				
139,7	20,8	23,3	25,9	28,3	32,0	35,1	39,5	44,0	48,6	52,7	59,0	64,3	71,1	77,0	81,1	92,0	98,3				
146	21,7	24,3	27,2	29,8	33,5	36,6	41,2	46,2	51,3	55,5	62,1	67,8	74,6	81,5	85,8	97,7	104				
152,4	22,8	25,5	28,4	31,0	35,1	38,5	43,4	48,5	53,6	58,1	65,3	71,3	79,0	85,8	90,5	103	112				
159	23,8	26,6	29,6	32,4	36,7	40,3	45,4	50,8	56,2	60,9	68,6	74,8	83,0	90,3	95,3	109	119				
168,3	25,3	28,3	31,5	34,5	39,0	42,9	48,4	54,1	59,9	65,0	73,1	80,0	88,9	96,7	102	117	126				
177,8	26,7	30,0	33,4	36,5	41,4	45,4	51,3	57,4	63,6	69,1	77,8	85,2	94,8	103	109	126	136				
193,7	29,2	32,8	36,5	40,0	45,3	49,8	56,2	63,0	69,8	75,9	85,7	93,9	105	114	121	140	151	167	179		
203	30,6	34,3	38,5	42,7	47,6	52,8	58,7	66,1	73,8	80,1	90,3	99,0	110	121	128	148	161	178	191		
219,1	33,2	37,2	41,5	45,4	51,6	56,7	64,1	71,9	79,8	86,9	98,2	108	120	132	140	162	176	196	211		

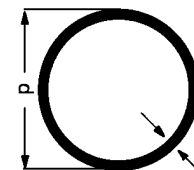

Diametro esterno mm	spessore mm																				
	6,3	7,1	8	8,8	10	11	12,5	14,2	16	17,5	20	22,2	25	28	30	36	40	45	50	55	60
	peso kg./mt.																				
227	34,3	38,5	43,2	47,3	53,5	58,6	66,1	74,5	83,2	90,4	102	112	124	137	146	170	186	207	224		
244,5	37,1	41,7	46,5	50,9	57,8	63,6	72,0	80,8	89,8	97,8	111	122	136	149	159	186	201	224	243		
254	38,5	43,2	48,5	53,9	60,2	66,8	74,4	84,0	93,9	102	115	127	141	156	166	194	211	235	255		
267	40,6	45,6	50,9	55,8	63,4	69,7	79,0	88,7	98,6	107	122	134	150	165	175	205	223	250	271		
273	41,6	46,7	52,1	57,1	64,8	71,4	80,9	90,9	101	110	125	137	154	169	180	211	229	256	275		
298,5		51,1	57,1	62,6	71,1	78,3	88,8	99,8	111	121	137	151	170	187	198	234	255	285	306	335	353
323,9		55,6	62,1	68,1	77,4	85,3	96,7	109	121	132	150	165	186	204	217	256	280	313	338	370	390
355,6				74,9	85,2	93,9	107	120	133	146	166	183	205	226	241	284	311	349	377	413	437
406,4				85,9	97,8	108	122	138	153	168	191	210	237	261	278	330	361	408	439	483	513
419				88,7	101	111	126	142	158	173	197	217	245	270	288	340	373	421	455	500	531
457,2					110	122	138	156	173	189	216	238	268	296	316	375	411	464	502	553	587
508						135	154	173	193	211	241	266	300	331	353	419	461	521	565	623	663
558,8							170	191	213	233	266	294	331	366	391	491	511	578	628	693	738
609,6					148	162	185	209	233	255	291	322	363	401	428	510	561	635	691	763	814
660,4					160	176	201	227	253	277	316	349	395	436	466	555	611	692	752	832	888
711,2						190	215	244	274	299	341	377	423	472	504	584	662	739	815	890	964

